

Board 32: Work in Progress: A Laboratory Platform for Learning for Chemical Engineering

Benjamin Miles Phillips, Baylor University

Ben Phillips is a PhD Candidate in the Department of Mechanical Engineering at Baylor University, working as a Research Assistant in the Baylor Energy And Renewable Systems (BEARS) Lab. His research interests are in Energy Storage and Renewable Systems, with projects focused in Concentrated Solar Thermal Energy Storage. He aspires to become a lecturer in the field of Chemical or Mechanical Engineering.

Dr. Anne Marie Spence, Baylor University

Clinical Professor Mechanical Engineering

Alexandre Yokochi

Work in Progress: A Laboratory Platform for Learning in Chemical Engineering

Abstract

This paper discusses the design, development, and evaluation of a Chemical Engineering Education Reactor (CEER). The goal of CEER is to provide a novel method to encourage student learning in the field of chemical engineering using a cooperative, hands-on, active, and problem-based environment. CEER is a small-scale water purification reactor that integrates chemical engineering (ChemE) concepts of heat and mass balances, heat and mass transfer, instrumentation and measurements, process control, reaction kinetics, and reaction engineering. The results of the quantitative and qualitative analysis of effects on learning of a preliminary design of the CEER on student learning will propel further developments in the platform with the goal of broadening applications of this reactor.

Introduction

From the authors' experience, chemical engineering (ChemE) students often have difficulty integrating the plethora of concepts presented in the several engineering science courses that compose a ChemE undergraduate program into an overall mental model of the discipline. To enhance the ability of students to synthesize the concepts they are presented in a survey course of ChemE, we are in the process of developing a learning platform based on a functioning miniature chemical plant, called a Chemical Engineering Education Reactor (CEER). Students learn well in a combination of lecture and discovery-based methods, where lecture provides base knowledge of the field and discovery methods encourage critical thinking and subject matter integration [1]. Incorporating active learning, like discovery methods, have been proven to improve concept tests more than any other form of instruction [2], encouraging further implementation of active learning. CEER will seek to take advantage of active learning benefits to teach individual concepts as well as how these concepts integrate.

CEER is intended to enable experimental work on topics including heat and mass balances, heat and mass transfer, instrumentation and measurements, process control, reaction kinetics, and reaction engineering. Thus, while seeking to enhance understanding of and confidence in these individual topics, CEER also intends to demonstrate the interconnection of the concepts through collaborative, hands-on experimentation in one complete system. This paper describes the design, implementation, and evaluation of this CEER learning platform.

Concept

This platform will allow the students to learn chemical engineering concepts in a cooperative, hands-on, active, and problem-based learning environment. This kind of product and teaching style has been proven effective by Washington State University, with their Low-Cost Desktop Learning Module's implementation in their Fluid Mechanics and Heat Transfer course [3].

The conceptual activities embodied in CEER are based on water treatment processes, with the core of the platform constructed around a simple continuously stirred tank reactor (CSTR) in which food-coloring-dyed water is decolorized with a dilute bleach solution illustrating the core chemical transformation. To enable exploration of reaction and reactor

kinetics, the flow rates of influent dye and bleach solutions are controlled, enabling the modification of dye and bleach concentrations and residence time in the CSTR. This enables the determination of the reaction kinetics in the system. Measurements of effluent dye concentration are enabled by simple colorimetry, illustrating the importance of Instrumentation and Measurements in the field.

To study the effect of temperature in reaction kinetics, the influent fluid flows are pre-heated using a reconfigurable water-to-water heat exchanger which can be used to validate classroom learning of heat transfer processes (i.e., heat transfer coefficient, the effect of co-current and countercurrent flow arrangements, and the concept of delta-T log mean driving force for the heat transfer process). An electric heating cartridge-based heater is also used so that the student can examine the equivalence of heat and electrical Joule heating.

Finally, the process is improved by extending reaction time through the use of a plug flow reactor in series with the CSTR. Upon completion of all these activities and activating all components, CEER will resemble and operate as a fully functional, albeit miniature, water disinfection plant. This is intended to enable the student to directly observe the integration of the subject of the topics involved in a ChemE course of study.

Design

As mentioned, CEER was designed to be focused on simulating water treatment processes. By focusing on simple decolorizing of food coloring dyed water with dilute solutions of bleach in small volumes the students are able to implement an extremely important process, the production of potable water from environmental water, in an intrinsically safe environment.

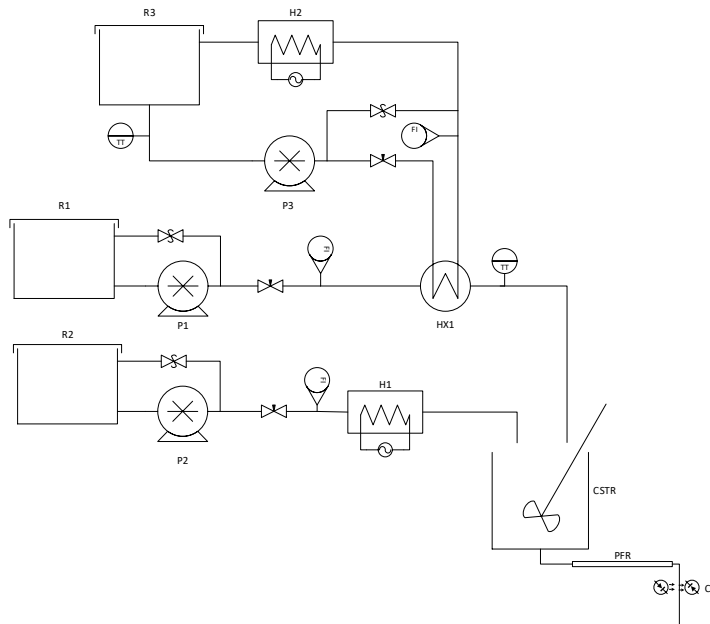

Figure 1. Process Flow Diagram of full CEER

Figure 1 gives a PFD of the current design for this reactor at its most complex scale. Ultimately, the efficiency of the water purification process can be objectively measured by the decrease of the concentration of food-dye in the effluent water. The water purification process at its simplest includes food-dyed water from R1 and low concentrations of bleach in R2 flowing

straight into a batch reactor (CSTR without an outlet). After a set amount of time, the “clean” water flows through the colorimeter to measure the concentration of food dye remaining in the water. Complexity increases with the following additions:

- Opening the valve at the outlet for continuous flow to create the CSTR.
- Including a set length of tubing following the reaction to create a PFR.
- Increasing the temperature of feed from R2 by including heater H1.
- Increasing the temperature of feed from R1 by running heated water line across HX1.

These additions allow for several parameters to be tested and evaluated on their effectiveness in improving the water purification process.

There are several controls and sensors used to operate and monitor this reactor. Mechanically, there are pressure regulators, on/off valves, and rotameters to control fluid flow. Electrically, an Arduino reads in values from the colorimeter, inline thermocouples, and slide potentiometers (used to vary the speed of the pumps), as well as sending out control voltages to the colorimeter, pumps, and LCD screen used to visually represent the system. Outside of the Arduino, there will be electrically powered inline water heaters and a magnetic stirrer that is controlled directly on the device and is powered by a 120V power source.

Assessment

As a trial version of the reactor, we presented a reduced CEER, as shown in Figure 2, a class of 8 graduate students and 8 undergraduate students in an upper-level mechanical engineering elective, Principles of Process Engineering, and evaluated how well the students increase in their ability to analyze the concepts demonstrated by the reactor. Both quantitative and qualitative methods will be used to assess impact of platform activity on student knowledge in the concepts discussed.

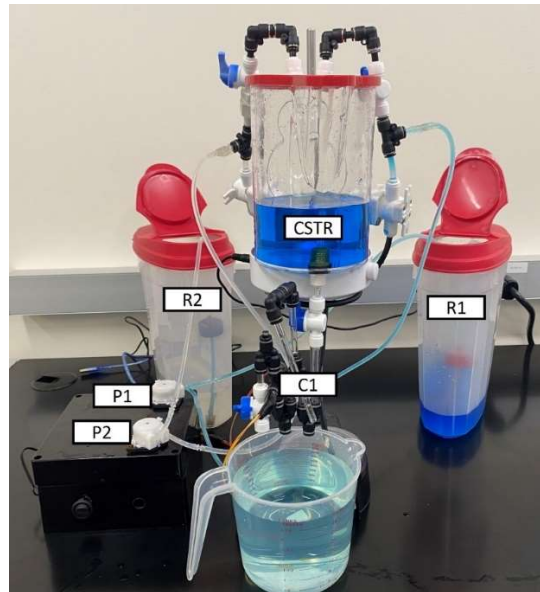

Figure 2. Image depicting a reduced CEER used in the preliminary demonstration.

The assessment, attached in Appendix A, is based on evaluation of the change in student performance on a simple survey of ChemE concepts before and after laboratory intervention. The method we used is similar to that performed by Ngothai and Davis [4], using questions from the American Institute of Chemical Engineering Education Division Concept Warehouse [5], with concept questions including thermochemistry, steady state vs. equilibrium, and chemical equilibrium. The number of concept questions was 17.

Following each concept question, the students were also asked about their confidence in their answer, with choices of High, Moderate, Low, and Total Guess. The change in performance and confidence determined our quantitative baseline of how well the CEER performed in terms of benefitting students' grasps on these concepts as well as provide insight into how the CEER should be improved in future iterations.

Preliminary Results and Discussion

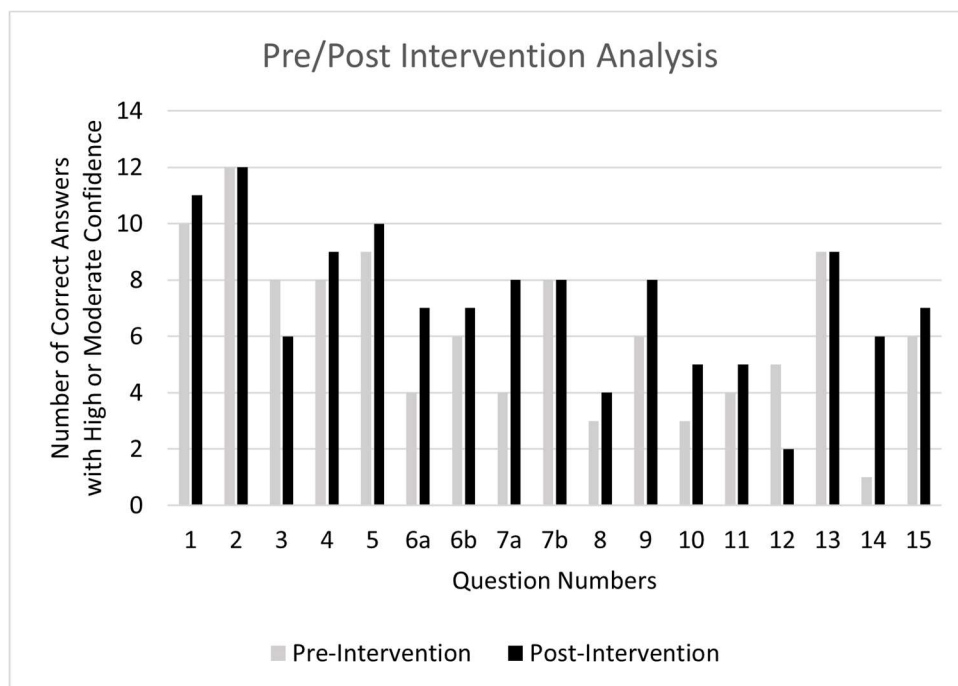

Figure 3. Combined quantitative and qualitative data from the pre- and post-intervention assessments.

Figure 3 shows the total change in number of correct answers on each question made with “High” or “Moderate” confidence. The notable changes are in questions 6a, 7a, and 14, where there was an increase of 3, 4, and 5 correct answers with “High” or “Moderate” confidence respectively. As shown in Appendix A, these questions relate to the topic of distinguishing the difference between steady-state and equilibrium. This is reasonable as the CEER interaction focused predominantly parameters that effect the steady state color concentration values leaving the CSTR, demonstrating the concept of steady-state. Students could also see equilibrium being reached when it was pointed out that the color of the effluent fluids was much clearer after sitting in the waste bucket a significant amount of time (10 minutes

or so). This shows the effect of interacting with the CEER in the lab on understanding the concept of steady-state versus equilibrium.

Next Steps

In order to improve the learning gained from interacting with the CEER, the CEER will be expanded into the full CEER design with more time for students to interact and explore the various components of this reactor. In the next application of this project, researchers will modify and improve the laboratory experiment that students will work through in order to increase student ability to apply in-class knowledge to this system that is more like what they would experience on the field.

End Goal

In future developments to push this toward applications across a whole degree plan, the researchers intend to open the process to enable the students to design and implement other processes, such as replacing the process implemented in the CSTR. Specifically, the idea of replacing the CSTR with a bioprocess (e.g., a simple fermentation using brewer's yeast), a membrane separation process, or a fractional distillation of a water/ethanol mixture are under consideration. The development of such further processes enables students to access the highest levels of cognitive processes in Bloom's taxonomy, by enabling designing and constructing a novel device.

References

1. Harrington, C. and T. Zakrajsek, *Dynamic lecturing : research-based strategies to enhance lecture effectiveness*. First edition. ed. The excellent teacher series. 2017, Sterling, Virginia: Stylus.
2. Freeman, S., et al., Active learning increases student performance in science, engineering, and mathematics. *Proceedings of the National Academy of Sciences - PNAS*, 2014. 111(23): p. 8410-8415.
3. Golter, P., B. Van Wie, and G. Brown. *Comparing Student Experiences And Growth In A Cooperative, Hands On, Active, Problem Based Learning Environment To An Active, Problem Based Environment*. Atlanta: American Society for Engineering Education-ASEE.
4. Ngothai, Y. and M.C. Davis, Implementation and analysis of a Chemical Engineering Fundamentals Concept Inventory (CEFICI). *Education for chemical engineers*, 2012. 7(1): p. e32-e40.
5. Koretsky, M. *AIChE Concept Warehouse*. 2010 [cited 2023 April 13]; Available from: <https://conceptwarehouse.tufts.edu/cw>.

Appendix A – Pre- Post-Intervention Assessment

1. Heat can best be described as:

- a. Energy flow from one body to another.
- b. Friction from particles rubbing together.
- c. A reading on a thermometer.
- d. The absence of cold.
- e. A substance that makes objects feel warm.

Indicate how confident you are in your responses for the previous question.

- a. Total Guess
- b. Low
- c. Moderate
- d. High

2. A block of copper is heated to 100°C. It is then left to cool down. Which of the following statements best describes the process of cooling down?

- a. The particles rubbing against each other over time will slow down creating less heat.
- b. The particles do not have room to vibrate in the solid and will slow down after the heating stops.
- c. There is a transfer of heat from the block to the surroundings.
- d. There is a transfer of temperature from the block to the surroundings.
- e. There is a transfer of cold from the surroundings to the block.

Indicate how confident you are in your responses for the previous question.

- a. Total Guess
- b. Low
- c. Moderate
- d. High

3. They will freeze at the same time because they are in the same freezer at the same temperature.

- a. The plastic tray because it has a higher specific heat and attracts heat away from the water.
- b. The plastic tray because it insulates the cold into the water.
- c. The metal tray because it conducts cold quickly into the water.
- d. The metal tray because it conducts heat quickly away from the water.

Indicate how confident you are in your responses for the previous question.

- a. Total Guess
- b. Low
- c. Moderate
- d. High

4. A bowl of soup and a metal spoon were at 70°C. Both cooled down to room temperature (25°C) Do they have the same heat change?

- a. Yes, heat and temperature are the same thing.
- b. Yes, they have the same heat change.
- c. No, they have different heat changes, but the same temperature change.
- d. No, they have different heat changes because heat easily leaves the spoon.
- e. No, they have different heat changes because they attract heat differently.

Indicate how confident you are in your responses for the previous question.

- a. Total Guess
- b. Low
- c. Moderate
- d. High

5. A bar of copper is heated to 30°C and then placed into a Styrofoam cup of water. Thermal equilibrium between the copper bar and water is reached at 40°C . What was the temperature of the water before the copper bar was dropped into it? Why?
- Less than 40°C because copper can hold more heat than water.
 - Less than 40°C because the copper bar heated the water.
 - Greater than 40°C because water can hold more heat than copper.
 - Greater than 40°C because the water heated the copper bar.
 - Greater than 40°C because the water and copper bar would cool down on their own without interacting with each other or anything else.

Indicate how confident you are in your responses for the previous question.

- Total Guess
- Low
- Moderate
- High

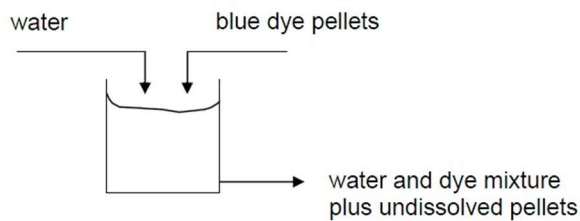

- 6a. Water and pellets of solid blue dye are steadily added to a beaker in separate streams as shown below. The water/dye mixture is steadily removed from the beaker so that the liquid level in the beaker remains constant. Undissolved dye pellets also leave the beaker so that no pellet buildup occurs in the beaker.

Indicate how confident you are in your responses for the previous question.

- Total Guess
- Low
- Moderate
- High

The beaker contents are well stirred so that the distribution of dissolved dye in the beaker is uniform (same dye concentration at all locations in the water).

Water and dye addition rates are constant and the total flowrate into the beaker is 1 liter/minute.

The beaker has a volume of 1 liter so the average time that water and dye spend in the beaker is 1 minute. If the time required for water and dye pellets to come to equilibrium is 2 minutes, what can we say about the water and pellets in the beaker?

- Water and pellets are in equilibrium and the system is at steady-state.
- Water and pellets are in equilibrium but the system is not at steady-state.
- Water and pellets are not in equilibrium but the system is at steady-state.
- Water and pellets are not in equilibrium and the system is not at steady-state.

6b. because:

- a. Since dye is dissolving, water and dye pellets are in equilibrium but the rate of dissolution means system can't be at steady-state
- b. The water and dye pellets don't have enough time to come to equilibrium but conditions in the beaker (e.g. temperature, pressure, volume, concentration) are not changing with time.
- c. The water and dye pellets don't have time to come to equilibrium in the beaker and therefore the system can never be at steady-state.
- d. Equilibrium and steady-state are related – you can't have one without the other.

Indicate how confident you are in your responses for the previous question.

- a. Total Guess
- b. Low
- c. Moderate
- d. High

7a. Table salt is slowly added to a beaker of water that is being stirred. Initially, all the salt dissolves in the water. As more salt is added, the water eventually becomes saturated with salt and some solid salt remains undissolved. Once solid salt is observed in the bottom of the beaker, no additional salt is added. Assuming the beaker contents are still well-stirred, we can say that:

- a. Salty water and solid salt are in equilibrium and the beaker system is at steady-state
- b. Salty water and solid salt are in equilibrium but the beaker system is not at steady-state
- c. Salty water and solid salt are not in equilibrium but the beaker system is at steady-state.
- d. Salty water and solid salt are not in equilibrium and the beaker system is not at steady-state.

Indicate how confident you are in your responses for the previous question.

- a. Total Guess
- b. Low
- c. Moderate
- d. High

7b. because:

- a. salt is always being dissolved on a molecular level so the system can never come to equilibrium.
- b. equilibrium and steady-state are related – you can't have one without the other.
- c. maximum amount of salt is dissolved (so net dissolution rate is zero) and conditions in the beaker (temperature, pressure, composition) are not changing with time.
- d. once the water is saturated, salt dissolution stops so system can't be at steady-state.

Indicate how confident you are in your responses for the previous question.

- a. Total Guess
- b. Low
- c. Moderate
- d. High

8. Compare the following two reactions:

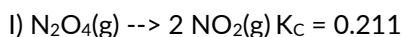

Which of the following statements is correct?

- a. Reaction I will proceed faster because K_C is larger.
- b. Reaction II will proceed faster because K_C is larger.
- c. Reaction I favors the production of products.
- d. Reaction II favors the production of products.
- e. None of these statements is correct.

Indicate how confident you are in your responses for the previous question.

- a. Total Guess
- b. Low
- c. Moderate
- d. High

9. If a reaction has an equilibrium constant that is significantly large ($K_C \gg 1$), which of the following statements can be made about the reaction?

- a. The reaction will favor production of reactants.
- b. The reaction will favor production of products.
- c. The reaction will proceed quickly.
- d. The reaction will proceed slowly.
- e. Both the rate of reaction and extent of reaction can be determined from K_C

Indicate how confident you are in your responses for the previous question.

- a. Total Guess
- b. Low
- c. Moderate
- d. High

10. Once a system reaches equilibrium:

- a. The forward and reverse reactions no longer occur.
- b. The forward and reverse reactions continue to occur and alter the concentrations of reactants and products.
- c. The forward and reverse reactions occur, but do not alter the concentrations of the reactants or products.
- d. Only the forward reaction continues to occur.
- e. Only the reverse reaction continues to occur.

Indicate how confident you are in your responses for the previous question.

- a. Total Guess
- b. Low
- c. Moderate
- d. High

11. Consider the following reaction:

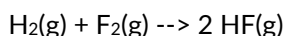

A flask containing these three chemical species is at equilibrium. Additional H_2 is added to the flask. As the system returns to equilibrium, which of the following compounds will experience a change in concentration as the system approaches equilibrium?

- a. H_2
- b. F_2
- c. HF
- d. Two of the above
- e. All of the above

Indicate how confident you are in your responses for the previous question.

- a. Total Guess
- b. Low
- c. Moderate
- d. High

12. Consider the following reaction:

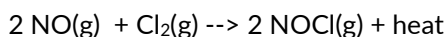

A flask containing NO(g), Cl₂(g), and NOCl(g) is at equilibrium. If additional NO(g) is added to the container, what happens to the system as it approaches equilibrium?

- First, all of the NO reacts and the forward reaction proceeds to completion. Then the reverse reaction occurs.
- The concentrations of NO, Cl₂, and NOCl fluctuate back and forth until a new equilibrium is established.
- NO and Cl₂ are used to make NOCl until one of the reactants runs out, limiting the production of more product.
- NO and Cl₂ are used to make NOCl until equilibrium is established. The forward and reverse reactions continue to proceed, but the concentrations no longer vary.
- The rate of the forward reaction continuously speeds up as the reaction proceeds and the rate of the reverse reaction slows down until equilibrium is reached.

Indicate how confident you are in your responses for the previous question.

- Total Guess
- Low
- Moderate
- High

13. Consider the following reaction:

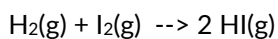

If H₂ and I₂ are mixed together and allowed to come to equilibrium, what would the graph of the concentration of H₂ look like over time?

Indicate how confident you are in your responses for the previous question.

- Total Guess
- Low
- Moderate
- High

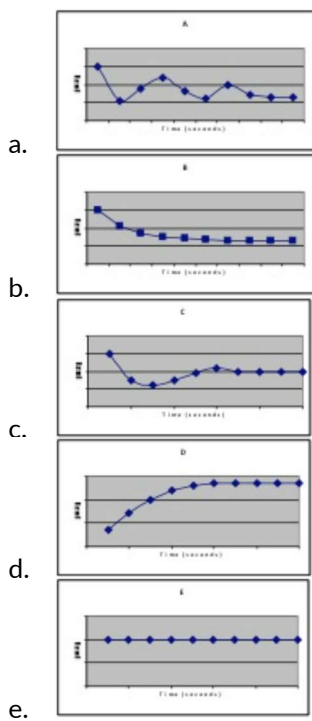

14. Consider the following reaction:



When the reaction is cooled down to room temperature, what happens to K_C ?

- a. Changing the temperature doesn't change K_C .
- b. K_C will decrease because of the lower temperature.
- c. K_C will decrease because the volume occupied by the gas becomes smaller.
- d. K_C will increase because of the lower temperature.
- e. K_C will increase because the volume occupied by the gas becomes smaller.

Indicate how confident you are in your responses for the previous question.

- a. Total Guess
- b. Low
- c. Moderate
- d. High

15. Consider the following reaction:

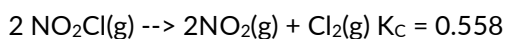

If the volume of this equilibrium system is cut in half, what will happen to the equilibrium constant?

- a. The new K_C will be larger than the original because of a temperature increase.
- b. The new K_C will be larger than the original because the reaction shifts to the left.
- c. The new K_C will be smaller than the original because of a temperature increase.
- d. The new K_C will be smaller than the original because the reaction shifts to the left.
- e. K_C will stay the same.

Indicate how confident you are in your responses for the previous question.

- a. Total Guess
- b. Low
- c. Moderate
- d. High